

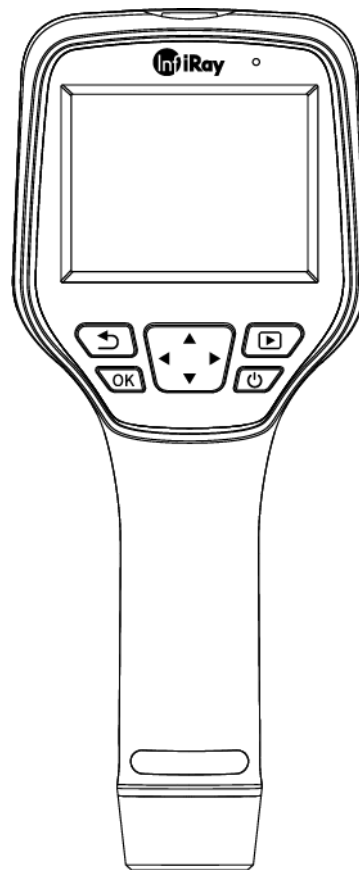

Uncooled Handheld Thermal Camera for Gas Leak Detection User Manual V1.0.3



IRay Technology Co., Ltd.

www.infiray.com

Explore And Perceive The Future

Introduction to IRay Technology

IRay Technology concentrates on developing infrared thermal imaging technologies and manufacturing relevant products, with completely independent intellectual property rights. IRay is committed to providing global customers with professional and competitive infrared thermal imaging products and solutions. The main products include IRFPA detectors, thermal imaging modules, and terminal thermal cameras and imagers.

With R&D personnel accounts for 48% of all employees, 1760 intellectual property projects in terms of IRay have been authorized and accepted: 1099 patented technologies authorized and accepted in China (including those for integrated circuit chips, MEMS sensors design and manufacture, Matrix IV image algorithms and intelligent precise temperature measurement algorithms, etc.); 277 trade mark applications in China; 35 patents and patent applications overseas; 107 trade mark applications overseas; 191 software copyrights; and 51 integrated circuit layout designs.(The statistic data is up to August, 2022)

IRay products have been applied in various fields, including industrial thermography, outdoor night vision observation, AI, machine vision, automatic driving, security and fire control, Internet of Things, and epidemic prevention and control.

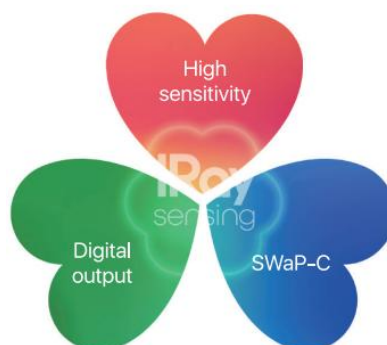

Table of Contents

1.Legal Disclaimer	1
1.1 Legal Disclaimer	1
1.2 Copyright	1
1.3 Quality Assurance	1
2.Safety Information	2
3.Notice to user	3
3.1 Calibration	3
3.2 Accuracy	3
3.3 Video Teaching	3
3.4 Documentation Updates	3
3.5 Scope of Application	3
4.Customer Help	3
4.1 FAQ	3
4.2 Download	3
5.Product Introduction	4
5.1 Camera (View from the front)	4
5.2 Buttons (View from the rear)	5
5.3 Connector and Memory Card	6
5.4 Product Specifications	6
6.Quick Start Guide	11
7.User Interface	12
8.Operation Instruction	13
8.1 Charging	13
8.1.1 Charge with a Power Adapter	13
8.1.2 Charge with a Computer	13
8.1.3 Charge with a Charging Base	13
8.2 Power On/Off	13
8.3 Focus Adjustment	14
8.4 Images/Videos Capture	14
8.5 View Photos/Videos	14
8.6 Set Gas Detection Mode	15
8.7 Measurement Parameters	15
8.8 Palettes	16
8.9 Image Mode	16
8.9.1 Image Mode Introduction	16
8.9.2 Setting Steps	16

8.10 Non-uniformity Correction	17
8.10.1 Non-uniformity Correction Introduction	17
8.10.2 Non-uniformity Correction Operations	17
8.11 Contrast Adjustment	17
8.12 Digital Zoom	18
8.13 Other Settings	18
8.13.1 Temperature Measurement Mode	19
8.13.2 Above/Below Temperature Alarm	19
8.13.3 Wi-Fi Settings	20
8.13.4 Photo Settings	21
8.13.5 Dual-spectrum Alignment	21
8.13.6 Automatic Power-off	22
8.13.7 System Settings	23
9. Structural Drawings	25
10. Cleaning Thermal Camera	26
10.1 Cleaning Camera Housing, Cables and Other Items	26
10.2 Cleaning Infrared Lens	27

1. Legal Disclaimer

1.1 Legal Disclaimer

The thermal cameras manufactured by IRAY TECHNOLOGY CO., LTD. (Hereinafter referred to as "THE COMPANY" or "IRAY TECHNOLOGY") are warranted for a period of two-year and the accessories are warranted for a period of three-month form the delivery date of the original purchase, provided such products have been under normal storage, use and maintenance.

This warranty extends only to the original purchaser and is not transferable. It is not applicable to any product which has be subjected to misuse, neglect, accident or abnormal conditions of operation.

In the case of a defect in a product covered by this warranty the product must not be further used or maintained in order to prevent additional damage. The purchaser shall promptly report any defect to IRAY TECHNOLOGY or this warranty will not apply.

IRAY TECHNOLOGY will, at its option, repair or replace any such defective product free of charge if, upon inspection, the product or accessories prove to be defective, the user can contact with after-sales service department of IRAY TECHNOLOGY within the said warranty period.

1.2 Copyright

©IRay Technology Co., Ltd. 2023. All rights reserved worldwide. All contents in this manual, including words, pictures, images, etc., belong to IRAY TECHNOLOGY. No part of the manual, in whole or part, may be copied, photocopied, translated, or transmitted without the prior written permission of IRAY TECHNOLOGY.

This manual is used as a guide. The photos, graphics, diagrams and illustrations provided in the manual are only used to explain, which may be different from the specific product. The real product shall prevail. We try our best to make sure the contents in this manual are accurate. We do not provide any representations or warranties in this manual.

IRAY TECHNOLOGY reserve the right to update the manual. If you need the latest version of this manual, please contact us. It is recommended that you use this manual with the guidance of professionals.

1.3 Quality Assurance

The Quality Management System under which these products are developed and manufactured has been certified in accordance with the ISO9001 standard.

We reserve the right to make changes and improvements on any of the products without prior notice.

2. Safety Information



WARNING

1. Make sure you read all applicable Material Safety Data Sheets (SDS) and warning labels on containers before you use a liquid. The liquids can be dangerous. Injury to persons can occur.
2. It is prohibited to use the product in a high temperature above 85 °C or in a low temperature below -45 °C.
3. It is forbidden to disassemble or refit the thermal camera at will.
4. Do not use too long screws when installing the front/rear mounting bracket, which may damage the thermal camera.



CAUTION

1. No matter there is a lens cover or not, do not point the infrared thermal camera towards strong light or equipment with laser radiation. This will affect the accuracy of the thermal camera and even damage the detector in the thermal camera.
2. Do not use the product under conditions that doesn't match the environmental requirements. For specific use environment requirements, see the product parameter table.
3. Do not apply solvents or equivalent liquids to the camera, the cables, or other items.
4. Be careful when you clean the infrared lenses. The lens has an anti-reflective coating which is easily damaged. Damage to the infrared lens can occur with too much force or cleaning with rough objects such as tissues.

3. Notice to user

3.1 Calibration

IRAY TECHNOLOGY recommends that you verify your calibration yearly in order to ensure accuracy. You can verify the calibration through IRAY TECHNOLOGY or third-party organizations.

3.2 Accuracy

The G Series handheld thermal cameras have temperature measurement function, for very accurate temperature measurement results, we recommended that you wait 5 minutes after you have started the camera before measuring a temperature.

3.3 Video Teaching

You can search for mount and use videos from our website.

3.4 Documentation Updates

Our manuals are updated several times per year, and we also issue product-critical notifications of changes on a regular basis. Please visit our website to access the latest manuals and notifications.

3.5 Scope of Application

This manual is applicable for all products in a range, which means that parts of the manual may not apply to a particular model.

4. Customer Help

4.1 FAQ

You can find answers to FAQ about this model on the service support page of our official website.

4.2 Download

You can download the following contents from our website: www.infiray.com

- Product Documentation
- Client Software
- Video Teaching Courses

5.Product Introduction

5.1 Camera (View from the front)

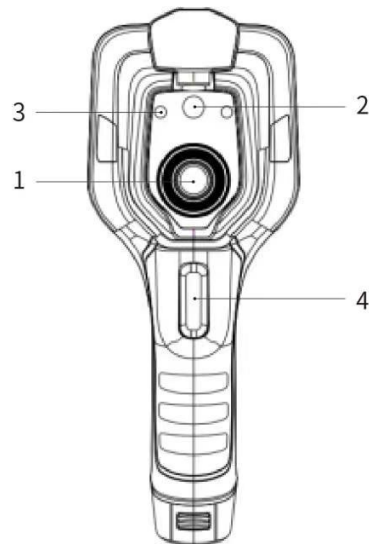

Figure5.1 Introduction to Camera Components

No.	Components
1	Infrared Lens
2	Digital Camera
3	Laser Pointer
4	Trigger

Note: the laser warning label is stuck on the lens cap.



5.2 Buttons (View from the rear)

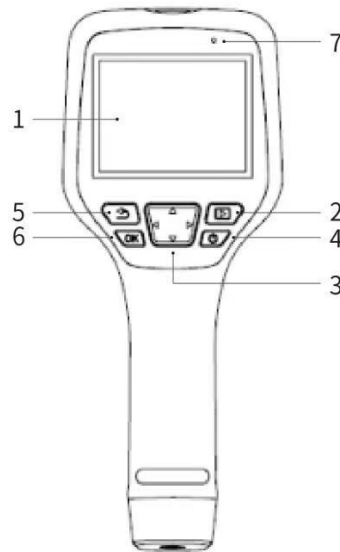

Figure5.2 Introduction to Buttons

No.	Components	Function Description
1	Display screen	
2	Gallery button	Press to open the gallery. Long press to perform image uniformity correction.
3	Navigation button	Make selections for the menu, settings, gallery by clicking up/down/left/right.
4	Power/Laser button	Click to turn on/ Long press to turn off. When it is on, click to turn on/off the laser pointer.
5	Back button	Click to cancel the operation or return to the previous one. Long press to perform image uniformity correction.
6	Enter button	Click OK to confirm the operation.

Table 5.2 Component Introduction (View from the Rear)

5.3 Connector and Memory Card

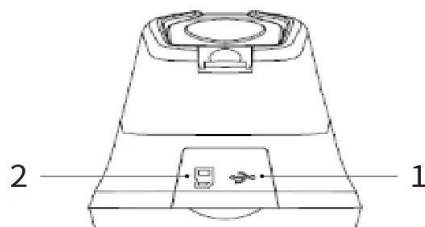

Figure 5.3 Illustration of Connector and Memory Card

No.	Name	Description
1	USB Interface	<ul style="list-style-type: none"> ● Connect a USB cable with the power adapter for charging. ● Connect a USB cable to a computer to charge or transfer data.
2	SD Card	<ul style="list-style-type: none"> ● Standard MicroSD card, standard 32GB, Max 512GB ● The SD card can be taken out and transfer data to PC or other devices with a card reader.

Table 5.3 Connector and Memory Card

5.4 Product Specifications

Technical Specifications		G600C	G600F
Thermal	Detector Type	Uncooled VOx infrared detector	Uncooled VOx infrared detector
	Detector Resolution	640x512	640x512
	Spectral Range	7.0-8.5 μ m	Central wavelength 10.55 μ m

Gases Detectable	Methane	Sulfur hexafluoride
	Nitrous oxide	Ammonia
	Sulfur dioxide	Ethylene
	Phenol	Ethylene ether
	Ethyl acrylate	Vinyl chloride
	2-Ethylhexyl acrylate	Trichloroethylene
	R13	Methyl vinyl ketone
	R13B1	Propylene
	R123	Acrolein
	R125	Acrylonitrile
R134A	Ethyl cyanoacrylate	
R417A	Allyl fluoride	
R422A	Allyl chloride	
R508A	Allyl bromide	
	Furan	
Pixel Pitch	12μm	12μm
Thermal Sensitivity	23mk@7-14um	23mk@7-14um
IFOV (spatial resolution)	0.63mrad	0.63mrad
Frame Rate	25Hz	25Hz
Focal Length	19mm	19mm
FoV	23°x18°	23°x18°
Focus Mode	Manual focus	Manual focus
Temperature Measurement Range	-20 °C- 120 °C	-20 °C- 120 °C
Temperature Measurement Accuracy	±2% or ±2°C	±2% or ±2°C
The Temperature Increment	0.1°C	0.1°C

Camera Function	Temperature Measurement Mode	Center spot/hot and cold spot tracing and temperature display	Center spot/hot and cold spot tracing and temperature display
	Self-defined Spots, Lines and Areas Measurement	Movable spot/line/area temperature measurement; Support 10 spots, 10 lines and 10 areas at most	Movable spot/line/area temperature measurement; Support 10 spots, 10 lines and 10 areas at most
	Temperature Measurement Unit	Celsius, Fahrenheit, Kelvin	Celsius, Fahrenheit, Kelvin
	Emissivity Setting	0.01-1.00, in 0.01 increment	0.01-1.00, in 0.01 increment
	Environmental Temperature Setting	-10~50°C, in 1°C increment	-10~50°C, in 1°C increment
	Distance Setting	1-20m, in 1m increment	1-20m, in 1m increment
	Image Mode	Infrared, visible, dual-spectrum fusion, PIP	Infrared, visible, dual-spectrum fusion, PIP
	Color Palettes	10 types	10 types
	Temperature Alarm	Yes	Yes
	Alarm Type	Image Alarm	Image Alarm
	Temperature Scale	Manual/Auto	Manual/Auto
	Laser Pointer	Yes	Yes
	Digital Camera	5MP	5MP
	Video/Image Storage	XX-IR.jpg (infrared image with temperature data) and XX-DC.jpg (visual image) ; Video without data	XX-IR.jpg (infrared image with temperature data) and XX-DC.jpg (visual image) ; Video without data
	Voice Annotation	Yes	Yes

	Language	Traditional Chinese, English, French, Spanish, Italian, Brazilian Portuguese, German, Polish, Russian, Korean, Hungarian, Turkish, Japanese.	Traditional Chinese, English, French, Spanish, Italian, Brazilian Portuguese, German, Polish, Russian, Korean, Hungarian, Turkish, Japanese.
	Display	3.5-inch touch screen (480x640)	3.5-inch touch screen (480x640)
	Image Naming	Automatic, manual, naming by scanning QR code	Automatic, manual, naming by scanning QR code
	Memory Card	Standard 32GB MicroSD card, support at most 512GB	Standard 32GB MicroSD card, support at most 512GB
	Battery Type	Rechargeable and removable Li-ion battery	Rechargeable and removable Li-ion battery
	Power Interface	USB Type C	USB Type C
	Connectivity Type	USB, SD card, Wi-Fi (AP mode)	USB, SD card, Wi-Fi (AP mode)
	Charging Time	About 3h	About 3h
	Battery Life	About 3h	About 3h
	Power Management	Automatic shutdown: 5min, 10min, 20min or disabled	Automatic shutdown: 5min, 10min, 20min or disabled
Others	Analysis Software	PC&APP	PC&APP
	Tripod Support	Yes	Yes
	Operating Temperature Range	-10 to +50°C	-10 to +50°C
	Storage Temperature Range	-20 to +60°C	-20 to +60°C
	Relative Humidity	10% ~ 95%, non-condensing	10% ~ 95%, non-condensing

Drop	2m	2m
Encapsulation Rating	IP54(IEC 60529)	IP54(IEC 60529)
Shock & Vibration	Shock :25g(IEC 60068-2-27); Vibration: 2.5g(IEC60068-2-6)	Shock :25g(IEC 60068-2-27); Vibration: 2.5g(IEC60068-2-6)
Dimensions (HxWxD)	256.4 x 105.1 x 105.3mm	256.4 x 105.1 x 105.3mm
Weight	About 670g	About 670g
Certifications	CE/FCC/UKCA/ROHS/ATEX	CE/FCC/UKCA/ROHS/ATEX
Accessories	5V 3A power adapter, USB cable, SD card, battery ×2, QSG, calibration certificate, battery charger, package list	5V 3A power adapter, USB cable, SD card, battery ×2, QSG, calibration certificate, battery charger, package list

6.Quick Start Guide

Please follow the procedures:

1.Charging

- (1) 5V 3A power adapter and USB cable can be used to charge the device.
- (2) You can charge the device by connecting the USB cable in the accessory to the computer.

Note: This method of charging takes longer time than using the power adapter.

- (3) Charging base can also be used to charge the battery.

2.Power on

Click the power button to start the device.

3.Target Searching

Point the thermal camera at the object of interest.

4.Image Capturing

Click the trigger button to capture the image, and record the video by long pressing the trigger button.

7.User Interface



Figure 7.1 User Interface

No.	Name	Description
1	Main Menu	Gas parameters, measurement parameters, measurement mode, image mode, color palettes and other settings can be set.
2	Sub Menu	specific options can be set, such as a specific color palette.
3	Temperature measurement spot	measurements of center spot, high/low temperature spot tracking, customize spot, customize line, customize area measurement are available.
4	Center spot temperature	the temperature of the center spot is displayed.
5	Date and time	date and time are displayed.
6	Battery capacity	the remaining battery capacity is displayed.
7	Temperature range	the temperature range in the current screen can be displayed.

Table 7.1 Interface Introduction

8.Operation Instruction

8.1 Charging

8.1.1 Charge with a Power Adapter

1. Plug the power adapter into the socket.
2. Use a USB cable to connect the adapter and the camera to charge.

Note: It takes about 3h to get the device fully charged.

8.1.2 Charge with a Computer

1. Use a USB cable to connect the thermal camera to the computer to charge.

Note: when charging with a computer, the computer should be turned on, and the charging time is longer than using an adapter.

8.1.3 Charge with a Charging Base

1. Connect the power adapter and the charging base with a USB cable, and plug the power adapter into the socket.
2. Take out the battery and place it correctly in the charging base to charge.

Note: When the battery is not placed, the indicator of the charging base flashes; the indicator turns red when the battery is placed and charging; the indicator becomes green when the battery is fully charged.

8.2 Power On/Off

1. Click the power button to start the device.
2. Press the power button about 3 seconds to turn it off.

8.3 Focus Adjustment

Make sure that the device is powered on, align the camera at the measured scene, rotate the focus ring beside the lens clockwise or counterclockwise, which can make the image clearer via focal length adjustment, see the following figure for the detailed adjustment method:

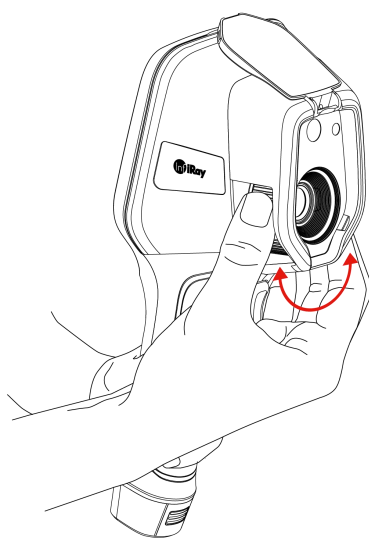

Figure 8.1 Focus Adjustment Through Focus Ring

8.4 Images/Videos Capture

1. In the observation interface, adjust the focus ring till the image is clear. Short press the trigger button to take the photo. Long press the trigger button to start recording video, release the trigger button to continue recording, and long press the trigger button again to stop recording.
2. Tap the save button on the touch screen or click the OK button or short press the trigger button to save the photos. Tap other buttons on the touch screen or use the navigation button + OK to scan the QR code to name the file, or cancel saving photos.

8.5 View Photos/Videos

The pictures you took are saved in the SD card, and you can follow the below steps to view them at any time.

1. Enter the photo gallery by clicking gallery button.
2. Select the picture or video you want to view by pressing the navigation button or screen.
3. Press OK or click the picture or video to view it in full screen. Select the delete option and then confirm

to delete the current item. Select the rename option and confirm to rename the current item.

4. When in the preview interface, click the multiple button in the upper right corner of the screen, then select the picture or video to be deleted, and delete the selected items by pressing the delete button.

5. Return to observation interface by clicking the gallery button, back button or touch screen.

8.6 Set Gas Detection Mode



On the observation interface, short press the OK button to show the main menu, and select the *Gas Detection Mode*  option, press the OK button again to show the sub menu, select On or Off by navigating left or right, then click the OK button to configure the parameters, click the OK button again to enable the function.

On the observation interface, click anywhere on the touch screen to show the main menu, click the *Gas Detection Mode*  option, click On or Off, click the image area to enable the function.

8.7 Measurement Parameters

In the observation interface, press OK to enter the main menu, use the navigation button to select the *Parameter Setting*  , then press OK again to enter the secondary menu. Select different temperature measurement parameters by shifting left or right, and press the enter button to parameterize. After setting, press OK again to save your option.

In the observation interface, click anywhere on the screen to enter the main menu. Click *Parameter Setting*  to set the parameter. After finishing the setting, click the screen area to take effect.

- **Emissivity**  : in order to obtain more accurate measurement results, you need to set the emissivity according to the target to be measured before each measurement, instead of using the default configuration. Emissivity refers to the ratio of the radiant ability of an object to the radiant ability of a blackbody at the same temperature, which is relative to the reflectivity of the object. The lower the emissivity, the higher the proportion of energy being reflected. The higher the emissivity, the lower the proportion of energy being reflected. For example, the emissivity of human skin is 0.98, and the emissivity of printed circuit boards is 0.91. For more information on emissivity, you can refer to the quick start guide in the package or inquire from other sources.
- **Ambient temperature**  : the reflection temperature of the object surface will affect the measurement result, especially when the object emissivity is low or the object temperature and the reflection temperature differ greatly, this effect will increase. So the result needs to be compensated to eliminate influences of the surface reflection temperature. However, it is usually difficult to determine the reflected temperature of an object. The ambient temperature can be used to replace the reflected temperature in actual measurement.

- **Distance**  : distances have effects on the measurement results. In order to get accurate measurement, distance information of the object is necessary for the thermal camera to compensate the result.

8.8 Palettes

In the observation interface, short press OK to enter the main menu, and select *Palette Setting*  with the navigation button. Press OK again to enter the sub menu, select different palettes by shifting left and right on the navigation button, and then press the enter button to save your option.

In the observation interface, click anywhere on the touch screen to enter the main menu. Click *Palette Setting*  to choose a palette and save your option by clicking the screen area.

8.9 Image Mode

8.9.1 Image Mode Introduction

Four image modes are available.

- Infrared: infrared image.
- Visible: visible image.
- PIP: infrared image superimposed at the center of the visible image
- Thermal Fusion: an image fused to a certain scale between an infrared image and a visible image

Note: For better dual-light image effects, when in PIP or thermal fusion modes, you need to set the actual distance, that is, the approximate distance from the thermal camera to the object. If the preset registration parameters cannot meet the requirements, you can also manually perform fusion registration in the settings.

8.9.2 Setting Steps

In the observation interface, press OK shortly to enter the main menu, and select *image mode*  through the navigation button. Then press OK again to enter the secondary menu, there different image mode can be selected by shifting left or right on the navigation button. Save your option by pressing enter button.



In the observation interface, click any place on the screen to enter the main menu. Click *image mode*  and select the desired image mode, and then click on the screen area. The option is saved.

8.10 Non-uniformity Correction

8.10.1 Non-uniformity Correction Introduction

Non-uniformity correction is used to compensate for non-uniformity of detector pixels or non-uniformity caused by other optical interference. When there are more noise in the image, non-uniformity correction is needed, which is common when the ambient temperature changes rapidly.

8.10.2 Non-uniformity Correction Operations

In the imaging interface, long press the back button  or the gallery button  to perform non-uniformity correction.

8.11 Contrast Adjustment

- In the observation interface, the contrast of the infrared image can be adjusted by sliding up and down the arrow button  on the temperature scale on the right side of the screen.

The default temperature scale is 24.2°C-34.6°C in the auto mode.

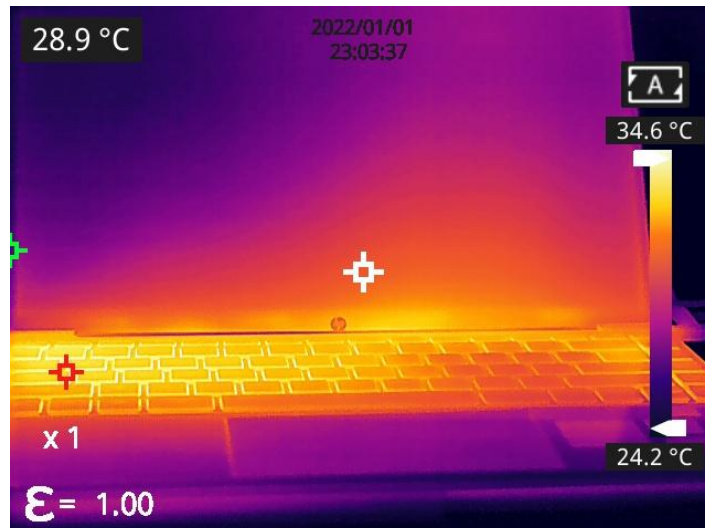

After the lower limit is changed to 27.7°C manually:

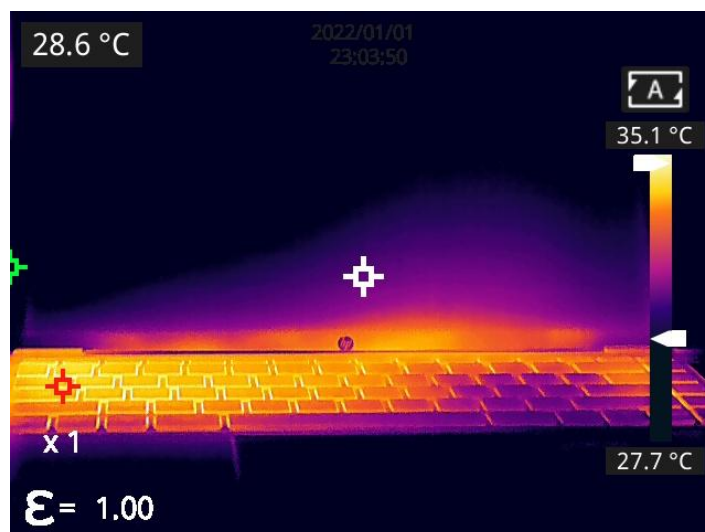

- Click the A button  in the bottom right corner to return to the auto contrast mode, the upper limit and lower limit will adjust automatically according to the Min temperature and Max temperature on the image, and the image color will distribute based on the color of the temperature scale.



8.12 Digital Zoom

In observation interface, press the navigation button to perform Max. 8×digital zoom.

Note: this function is only enabled under infrared mode or visible mode.

8.13 Other Settings

Other settings include date and time, unit, language and other items.

- 1) In the observation interface, short press the OK button to enter the main menu, and select *Settings*  via the navigation button, then press the OK button to enter other settings.
- 2) In the observation interface, tap anywhere on the screen to enter the main menu, and tap *Settings*  to enter other settings.

8.13.1 Temperature Measurement Mode

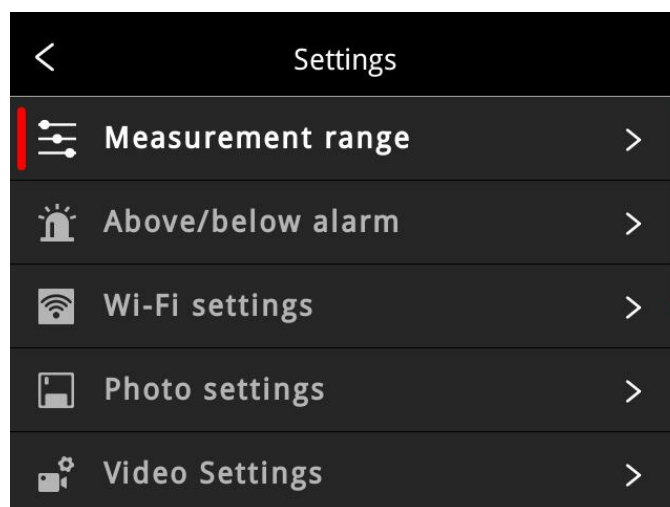

- -20~120°C: the device supports thermal imaging between -20°C and 120°C.

8.13.2 Above/Below Temperature Alarm

1.High temperature alarm switch: click to enable or disable the function of high temperature alarm.

Temperature setting for high temperature alarm: click on the pop-up keyboard and set the alarm temperature, 120°C by default.

2.Low temperature alarm switch: click to enable or disable the function of low temperature alarm. Function.

Temperature setting for low temperature alarm: click on the pop-up keyboard and set the alarm temperature, 0°C by default.

- Auto Alarm Snapshot: click to enable or disable, disable by default. Auto capture image during alarm.
- Time Interval: the time interval of alarm snapshot is 10s by default, click to perform custom setup.
- Number of Snapshot: 100 by default, click to perform custom setup.

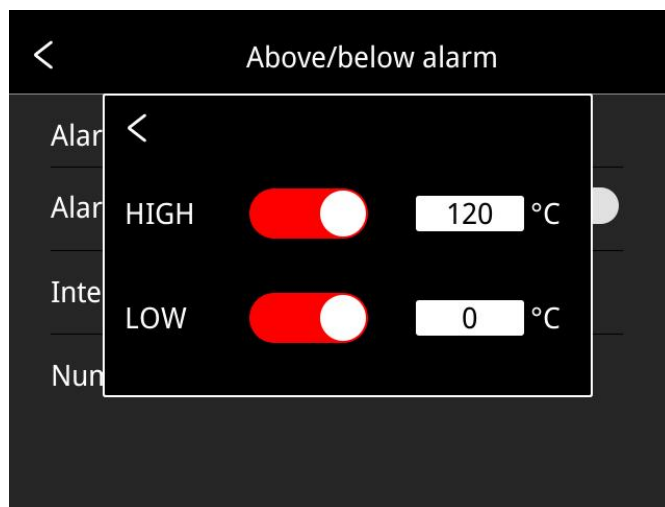
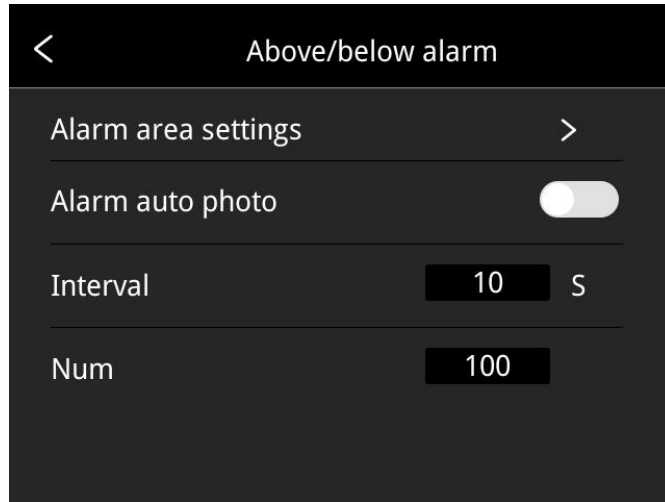

8.13.3 Wi-Fi Settings

Click and enter Wi-Fi settings interface.

- Hotspot Switch: turn on hotspot and set the network name and password, then click OK.

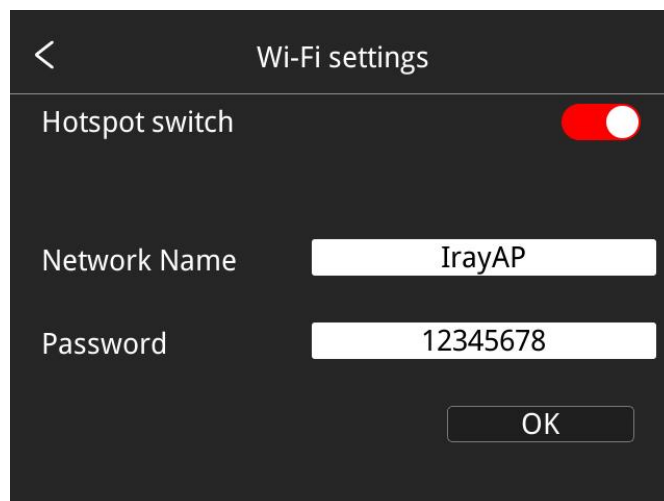

Note:

- 1)The specialized app is needed while this function is enabled. You need connect the hotspot manually after turning hotspot on, and you can transmit the saved pictures or videos to mobile device to perform secondary analysis.
- 2)Turn off hotspot when it is not used, or else the power consumption will be faster.

8.13.4 Photo Settings

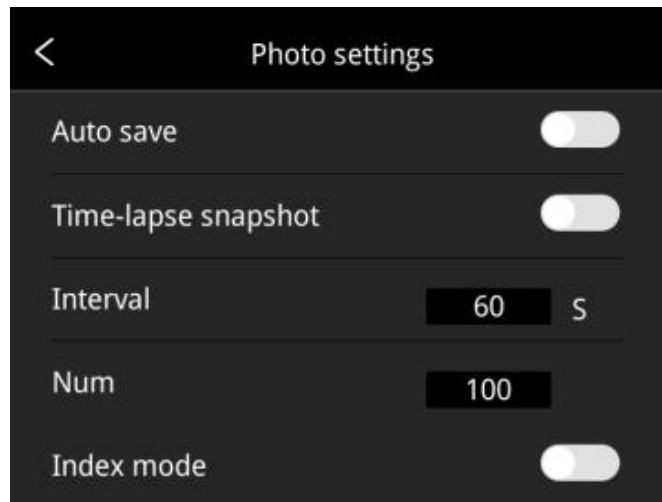

- Auto save of manual snapshot switch: click to enable or disable the function of auto save of manual snapshot, disabled by default.
- Time-lapse snapshot: click to enable or disable the function of time-lapse snapshot.
- Time interval of time-lapse snapshot: 60s by default, click to perform custom setup.
- Number of time-lapse snapshots: 100 by default, click to perform custom settings.
- Index mode: the file name is Time_Index_DC/IR.jpg by default if the index mode is enabled; the file name is Time_DC/IR.jpg if the index mode is disabled.

8.13.5 Dual-spectrum Alignment

- Dual-spectrum Fusion Alignment

This function can be used to manually register infrared and visible images. First select coarse tuning and fine tuning, and then perform image alignment through navigation buttons. After finished, click OK or enter button to save the settings. (You can drag on the touch screen with one finger to achieve fusion alignment in dual-spectrum fusion mode).

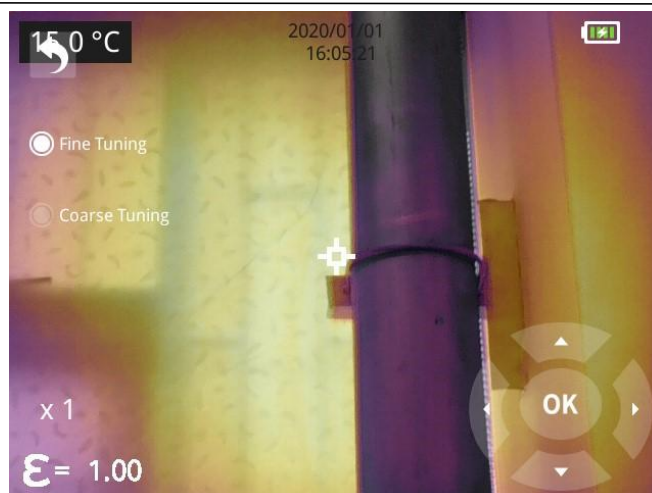

- **Picture-in-picture Adjustment**

This function can be used to adjust the position of the picture-in-picture. First select coarse tuning and fine tuning, and then adjust the position of the picture-in-picture by the navigation buttons. When finished, click OK or enter button to save the settings. (You can move the PIP by dragging the picture with your one finger, and adjust the PIP size by dragging the picture edges).

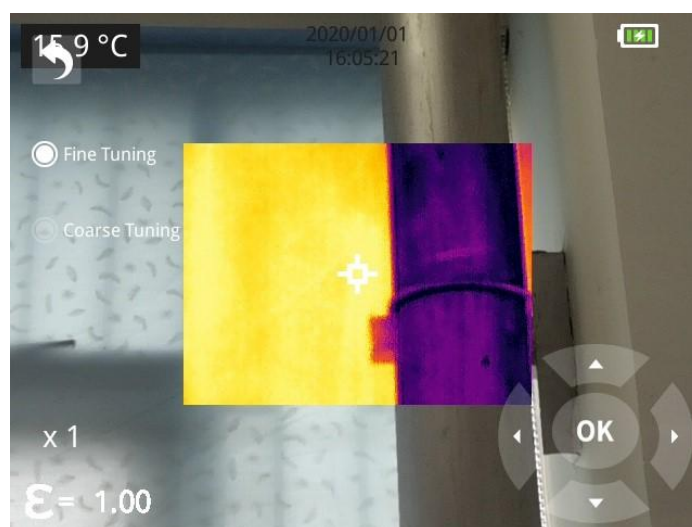

8.13.6 Automatic Power-off

- 5Min: click to perform auto shut down after 5 minutes.
- 10Min: click to perform auto shut down after 10 minutes.
- 20Min: click to perform auto shut down after 20 minutes.
- Off: Click to disable the function of auto shutdown, this function is disabled by default.

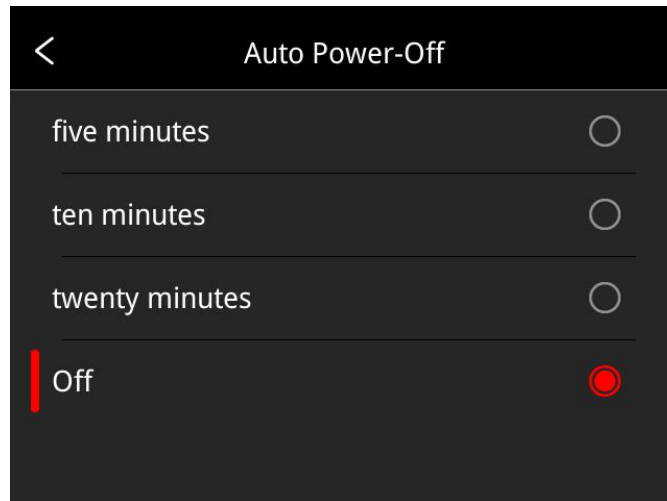

8.13.7 System Settings

1. Device Information

Click to check model, version, SD card capacity and SD card remaining capacity.

2. Date & Time

Click to perform date and time settings. The year can be self-defined from the Year 2020 to the Year 2037, the month, day, hour and min can be changed.

3. Unit

(1) Temperature Unit: switch between Celsius, Fahrenheit and Kelvin.

(2) Distance Unit: switch between meter and foot.

4. Screen Brightness

Click to perform date and time settings.

- High: click to set the screen brightness as high brightness.
- Medium: click to set the screen brightness as medium brightness, medium brightness by default.
- Low: click to set the screen brightness as low brightness.

5. Formatting the SD Card

Click and then press OK to format the SD card as FAT32.

6. USB Mode

There are two options for data transmission: U disk and USB camera.

- U disk mode: the saved images and videos can be read and analyzed when the camera is connected with other devices via a data cable in this mode.
- USB camera: the real-time image view and spot/line/region analysis can be achieved on the PC when the camera is connected with the PC via a data cable in this mode.

7. Restore Factory Settings

Click and then press OK, the camera will power off automatically a few seconds later, the settings will restore to the factory default state after reboot.

8. Software Update

Download the latest software to *Update* file in SD memory, click *Update from SD memory* to update. The camera will power off automatically, the software will update to the latest version after reboot.

9. Structural Drawings

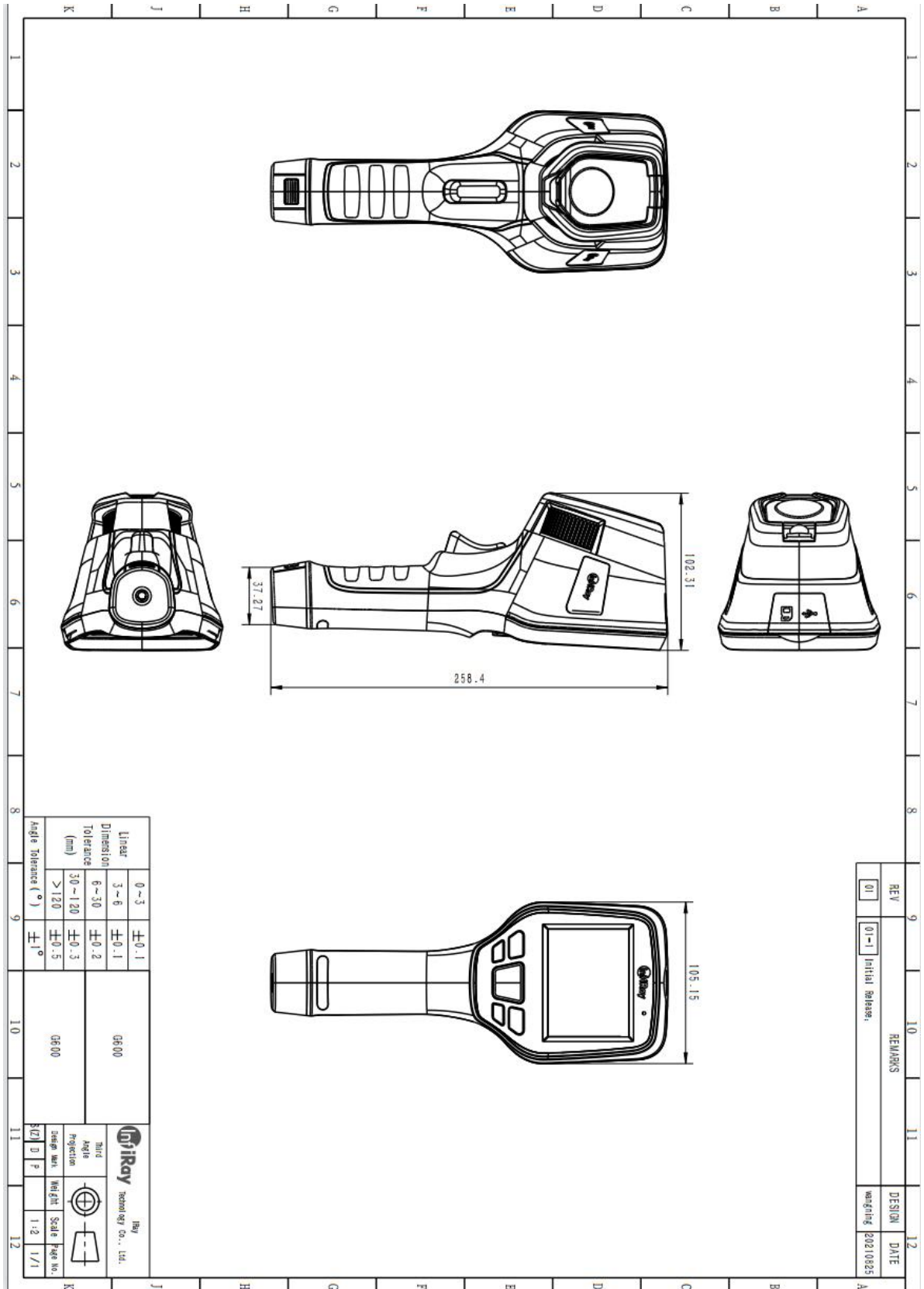

10.Cleaning Thermal Camera

10.1 Cleaning Camera Housing, Cables and Other Items

Camera Housing, Cables and Other Items	
Liquids	One of the following liquids can be used. 1.Warm water 2.A Weak detergent solution
Cleaning Tools	A soft cloth
Cleaning Procedure	Please follow this procedure: 1.Soak a soft cloth in the liquid. 2.Twist the cloth to remove excess liquid. 3.Clean the camera parts with the cloth.



CAUTION

Do not apply solvents or similar liquids to the camera, the cables, or other items. This can cause damage.

10.2 Cleaning Infrared Lens

Cleaning Infrared Lens	
Liquids	One of the following liquids can be used. 1. Commercial lens cleaning liquid with more than 30% is isopropyl alcohol. 2. 96% ethyl alcohol(C_2H_5OH).
Cleaning Tools	cotton wool
Cleaning Procedure	Please follow this procedure: 1. Soak the cotton wool in the liquid. 2. Twist the cotton wool to remove the excess liquid. 3. Clean the lens one time only and discard the cotton wool.



CAUTION

Do not clean the infrared lens too vigorously. This can damage the anti-reflective coating.

Worth comes from Service

24h Hotline:

400-998-3088

Technical Support

Hotline:

400-883-0800

Customized Services